







ST 050 308 1360



- shower with fixed riser projection 420mm
- Rain shower: PURE RAIN, max. flow rate 14 l/min (at 3 bar)
- rain shower Ø 200 mm
- rain shower with anti-scale system
- Hand shower: Three or five settings: COMPACT RAIN, COMPACT SOFT FLOW, COMPACT AQUAPRESSURE FLOW, max. flow rate 6.8 l/min (at 3 bar)
- spray head Ø 95mm
- rotary diverter for fixed-riser shower/hand shower
- height of fittings up to rain shower (bottom edge) 985mm
- height of fittings up to top edge of elbow 1160mm
- two-part push-on rosette Ø 65 mm
- rosette for shower holder Ø 65mm
- rosette for wall mounting Ø 60mm
- gauge 150 mm - 13 mm
- metal shower hose 1250mm with integrated anti-twist protection
- 1/2" connection
- Pipe diameter 20 mm

	Platinum	ST 050 308 1360-08 0050
	Chrome	ST 050 308 1360-00 0050
	Brushed Platinum	ST 050 308 1360-06 0050
	Durabrace (23kt Gold)	ST 050 308 1360-09 0050
	Brushed Durabrace (23kt Gold)	ST 050 308 1360-28 0050
	Brushed Dark Platinum	ST 050 308 1360-99 0050

Individual components of this set

You need the following components for this set

	1x	11 420 360-08		1x	28 002 978-08 0050
	1x	34 459 360-08 0050			









MADISON Showerpipe with shower thermostat - Platinum

MADISON

ST 050 308 1360

ST 050 308 1360



	Platinum	11 420 360-08
	Chrome	11 420 360-00
	Brushed Platinum	11 420 360-06
	Durabress (23kt Gold)	11 420 360-09
	Brushed Durabress (23kt Gold)	11 420 360-28
	Brushed Dark Platinum	11 420 360-99



MADISON Showerpipe with shower thermostat - Platinum

MADISON

ST 050 308 1360



MADISON Showerpipe with shower thermostat - Platinum

MADISON

ST 050 308 1360

ST 050 308 1360



ST 050 308 1360

Parts for other finishes can be found here: [Chrome](#)

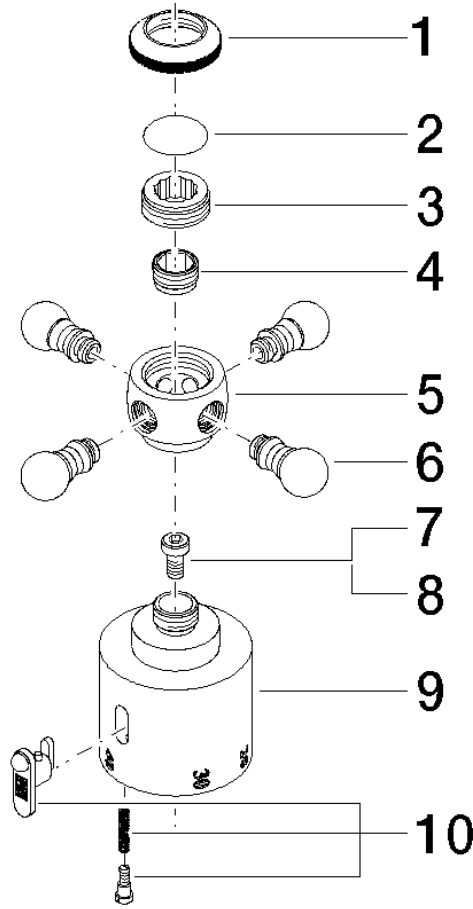

Spare parts list

No.	Item Number	Name	Quantity used	Delivery time
1	09 20 36 005-08	handle	1	40
2	09 26 01 016 90	accessories	1	2
3	09 20 83 006 90	handle	1	2
4	09 24 03 119 90	nipple	1	2
6	09 20 36 004-08	handle	4	40
7	90 30 30 027 00 90	screw	1	2
8	09 30 33 004 90	screw	1	2
10	90 21 33 020 00 90	handle	1	2

ST 050 308 1360



- Three settings: COMPACT RAIN, COMPACT SOFT FLOW, COMPACT AQUAPRESSURE FLOW, max. flow rate 6.8 l/min (at 3 bar)
- with anti-scale system
- spray head Ø 95mm
- 1/2" connection
- This product can help a building meet the requirements of Green Building Rating Systems, e.g. LEED®, BREEAM®, DGNB

Intrinsic protection against back flow.

	Platinum	28 002 978-08 0050
	Chrome	28 002 978-00 0050
	Brushed Platinum	28 002 978-06 0050
	Durabronze (23kt Gold)	28 002 978-09 0050
	Dark Chrome	28 002 978-19 0050
	Brushed Light Gold	28 002 978-27 0050
	Brushed Durabronze (23kt Gold)	28 002 978-28 0050
	Matte Black	28 002 978-33 0050
	Brushed Bronze	28 002 978-42 0050
	Brushed Champagne (22kt Gold)	28 002 978-46 0050
	Champagne (22kt Gold)	28 002 978-47 0050
	Brushed Chrome	28 002 978-93 0050
	Brushed Dark Platinum	28 002 978-99 0050



MADISON Showerpipe with shower thermostat - Platinum

MADISON

ST 050 308 1360

ST 050 308 1360

mm [inches]

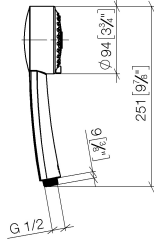

Flow rate chart

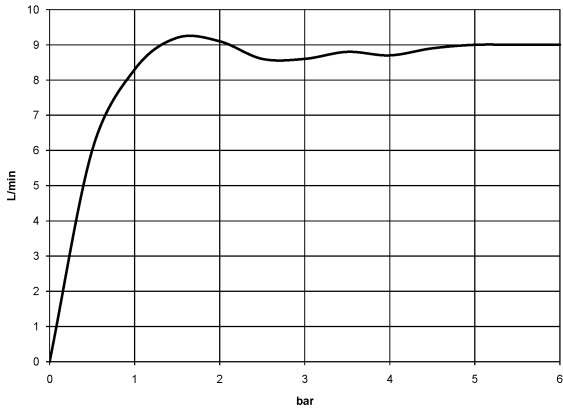

Spare parts list

No.	Item Number	Name	Quantity used	Delivery time
1	09 21 02 115 90	cap	1	2
2	09 23 01 039 90	sieve	1	2
3	04 12 11 071 00 90	shower	1	2
4	09 30 09 022 90	key	1	2







ST 050 308 1360



- shower with fixed riser projection 420mm
- rain shower Ø 200 mm
- rain shower with anti-scale system
- max. rainshower flow 14 l/min
- rotary diverter for fixed-riser shower/hand shower
- height of fittings up to rain shower (bottom edge) 985mm
- height of fittings up to top edge of elbow 1160mm
- two-part push-on rosette Ø 65 mm
- rosette for shower holder Ø 65mm
- rosette for wall mounting Ø 60mm
- gauge 150 mm - 13 mm
- metal shower hose 1250mm with integrated anti-twist protection
- 1/2" connection
- Pipe diameter 20 mm
- This product can help a building meet the requirements of Green Building Rating Systems, e.g. LEED®, BREEAM®, DGNB

This article does not include a hand shower!

Intrinsic protection against back flow.

	Platinum	34 459 360-08 0050
	Chrome	34 459 360-00 0050
	Brushed Platinum	34 459 360-06 0050
	Durabrace (23kt Gold)	34 459 360-09 0050
	Brushed Durabrace (23kt Gold)	34 459 360-28 0050
	Brushed Dark Platinum	34 459 360-99 0050



MADISON Showerpipe with shower thermostat - Platinum

MADISON

ST 050 308 1360

ST 050 308 1360

1:10

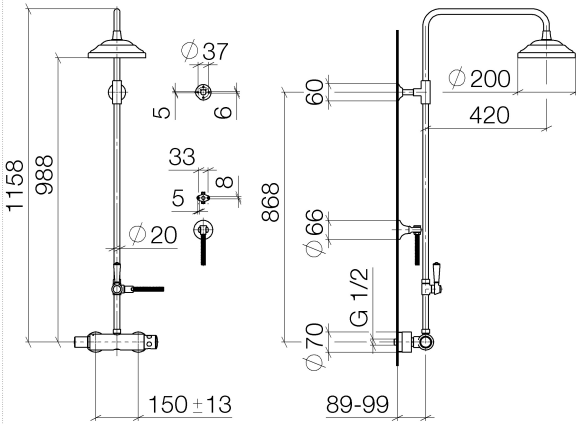

Flow rate chart

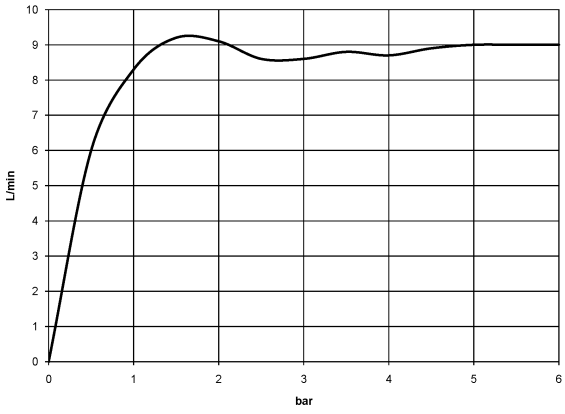

ST 050 308 1360

Parts for other finishes can be found here: [Chrome](#)

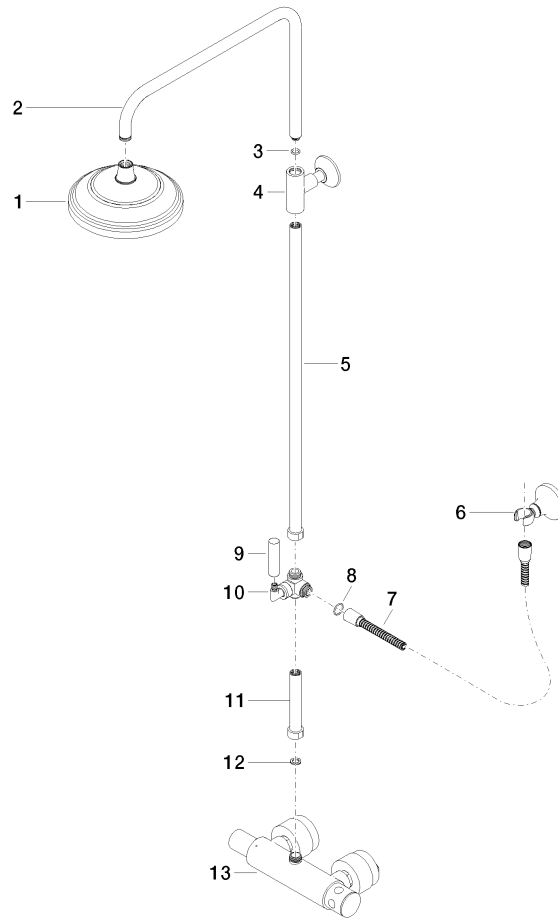

Spare parts list

No.	Item Number	Name	Quantity used	Delivery time
1	90 12 05 038 20-08	shower	1	40
2	04 28 22 101 20-08	spout	1	40
3	90 14 10 011 00 90	seal	1	2
4	90 17 11 037 01-08	holder	1	-
Spare part can no longer be ordered, please order the replacement item				
5	90 28 22 104 00-08	pipe	1	-
Spare part can no longer be ordered, please order the replacement item				
6	90 17 09 045 01-08	diverter	1	40
7	09 30 30 064-08	screw	1	40
8	09 18 20 011-08	base	1	40
9	09 28 22 013 90	pipe	1	2
10	11 170 370-08	MADISON Lever insert - Platinum	1	40
11	09 30 30 062-08	screw	1	40
12	09 14 10 122 90	seal	1	2
13	28 104 970-08	Metal shower hose 1/2" x 1/2" x 1250 mm - Platinum	1	40
14	28 050 410-08	holder	1	60
15	90 28 22 103 00-08	pipe	1	-
Spare part can no longer be ordered, please order the replacement item				
16	90 14 20 002 00 90	seal	1	2
17	04 17 01 044 01-08	fitting	1	40